



# KANGA PRODUCTS

Electronic Kits For The Radio Amateur

## Universal CW Memory Keyer (4 channel Memory Keyer)

This is a feature rich low-cost memory Keyer, offering features that you would expect from Keyers that are much more expensive. Unlike most keyers this is designed to work with all transistorised, Valve, or Hybrids rigs and will work with the older Grid Block or Cathode Keying methods favoured by older Kenwood and Heathkit as well as the most modern radios around.

The Keyer is built around a small but powerful microcontroller. The code for the chip is open source from Jan DK3LJ who developed the original program, later modified by Jack AL4SV and then further modified by Don WD9DMP who made some changes that polished Jacks code even more. The final product rivals professional Keyers costing many times the price.



This open source code is now installed on a small but powerful microcontroller. The kit produces a desktop mounting Keyer with many options.

Here is a list of its features.

- Iambic A, B, Ultimatic modes
- DAH Priority Mode
- Paddle Swapping
- Sidetone Toggle
- Adjustable Sidetone Pitch
- ATU Tune Feature (20 Sec Key Down) with one touch cancel
- TX Keying Toggle (Sidetone only for practice)
- TX Level Inverter mode
- WPM Speed feedback
- 4 x 100 char Memory's
- Automatic Beacon (for FOX hunts extra)
- Callsign CW Trainer (Sends random callsign, users send back)

Plus more...

For more details of each feature read the user guide at the end of this document.



# KANGA PRODUCTS

Electronic Kits For The Radio Amateur

## Parts List

uOSK cased PCB  
Attiny85 OSK Code  
DIP8 Socket  
R1, R2, 3K9 Resistor  
R4, R5 2K2 Resistor  
R3 39 Ohm Resistor (value changed for new improved sounder )  
R6 10K Trim Pot (Sidetone Volume)  
C1, C5 100nF (0.1uF) disk Marked 104  
C2,C3, C4 10nF (0.01uF) disk Marked 103  
U1 78L05 Voltage regulator  
T1 and T2 2N2222 amplifier Transistors  
2 x 3.5mm PCB Jack socket  
2.1mm DC Jack Socket  
Piezo Sounder  
Push Button  
PCB Inline Relay  
2 x 3 way Header Pins  
1 x 2 way Header Pin  
3 x 2 Pin jumper  
2 x M3 PCB Screws  
3mm Red LED  
3mm Orange LED  
Keyer 2 part case  
Case Front Panel  
Case Rear Panel  
Case Sticker  
2 x Case fixing screws  
4 x stick on feet

## The circuit board.

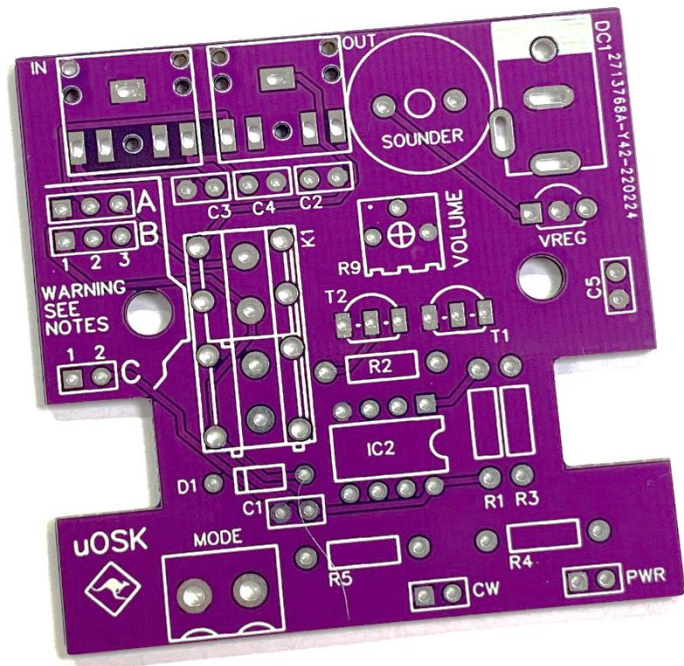



# KANGA PRODUCTS

Electronic Kits For The Radio Amateur

OK so let's make a start building the keyer.

I have given an order to fit the parts below, if you are experienced in kit building you do not need to follow this, it's an easy build and the parts are widely spread over the board, it should not prove very difficult to build.

If you are new to kit building just follow the instructions below.

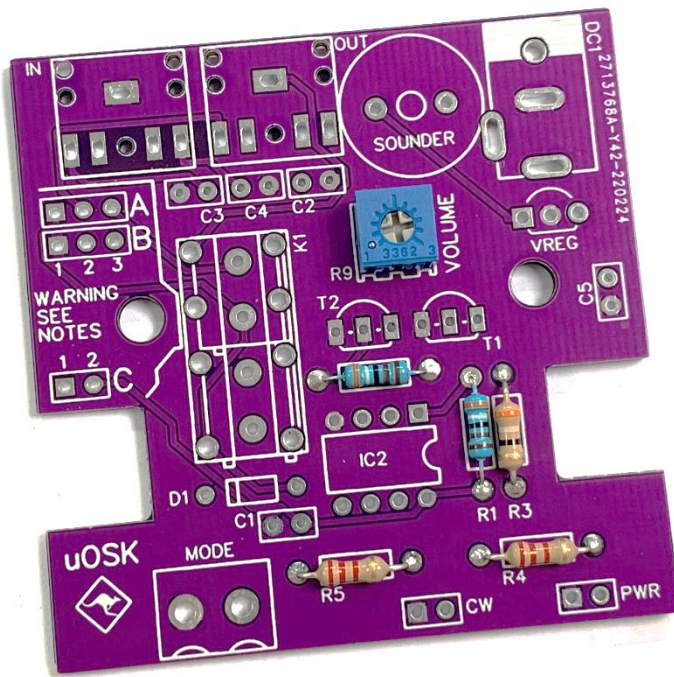

## First, The Resistors

There are six resistors to fit, start with R1 and R2 which are both 3k9 resistors. They have 5 coloured bands that are Orange, White, Black, Brown and Brown. Next fit R3 (Orange, White, Black, Gold). It is important not to get these resistors mixed up.

Next fit R4 and R5, both are 2k2 resistors (Red, Red, Red, Gold)

Finally Fit R6 which is a 10K Trimmer. This is used to set the sidetone volume and you can adjust this to suit your liking when you use the keyer

Next, we will fit the larger sockets.

The Key and out sockets are PCB mounting 3.5mm sockets that can only be fitted one way round, just make sure all the pins go through the board and none are folded under the socket when you push them through the board. The DC socket has 3 large pins, make sure all 3 are well soldered.

The final socket is one for the IC, The IC socket has a small notch on one edge, this should be lined up with the notch on the silk screen layout (notch nearest to R1/R3)

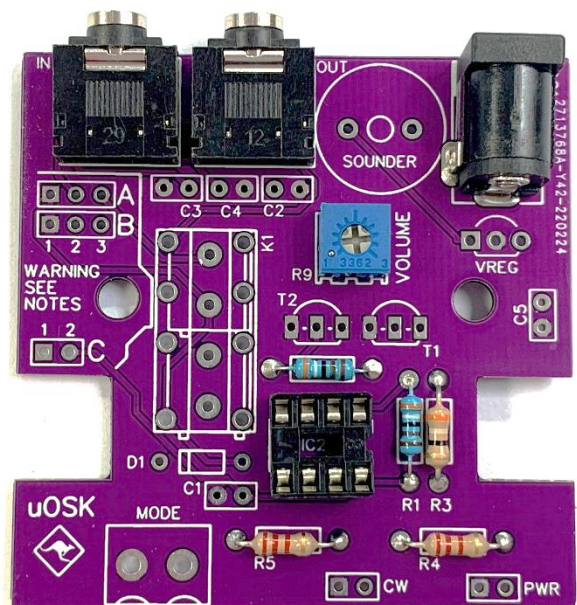



# KANGA PRODUCTS

Electronic Kits For The Radio Amateur

Now fit the capacitors,

C1, C5 are 100nf (marked 104) and the others (C2, C3, C4) are 10nf, marked 10nf.

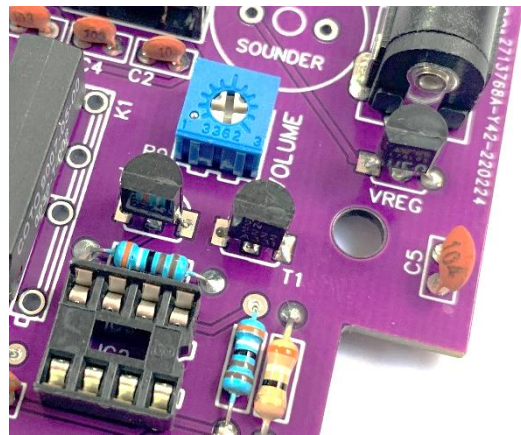
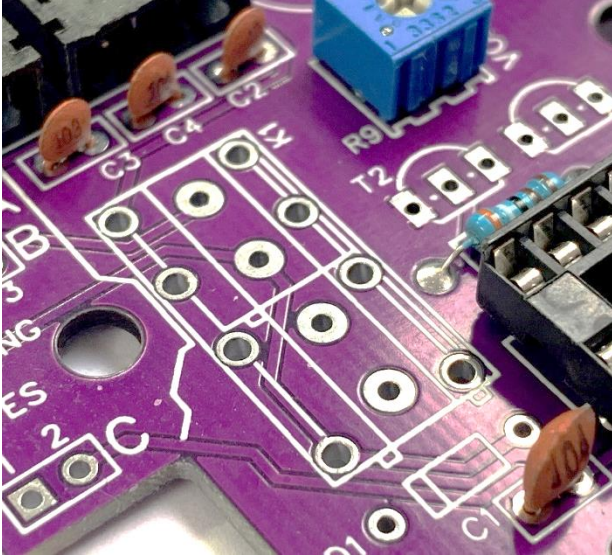

Now we need to fit the PCB relay. There are two possible relays that can be used with the keyer. one is a standard miniature signal relay and the other is a PCB inline reed relay, the miniature relay is the one that is normally supplied due to higher voltage contact rating but either are fine and depending on supply availability you may get either in the kit,

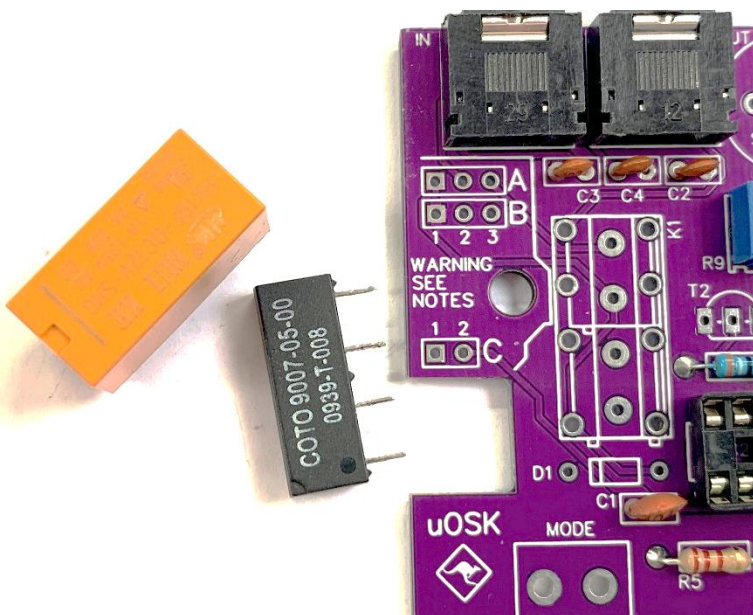

The signal relay (orange in this photo, or on the left if reading a black and white printed copy) will only fit on the board one way as the pins are offset. The inline relay is to be fitted with the printed text nearest to the T2 position.



# KANGA PRODUCTS

Electronic Kits For The Radio Amateur

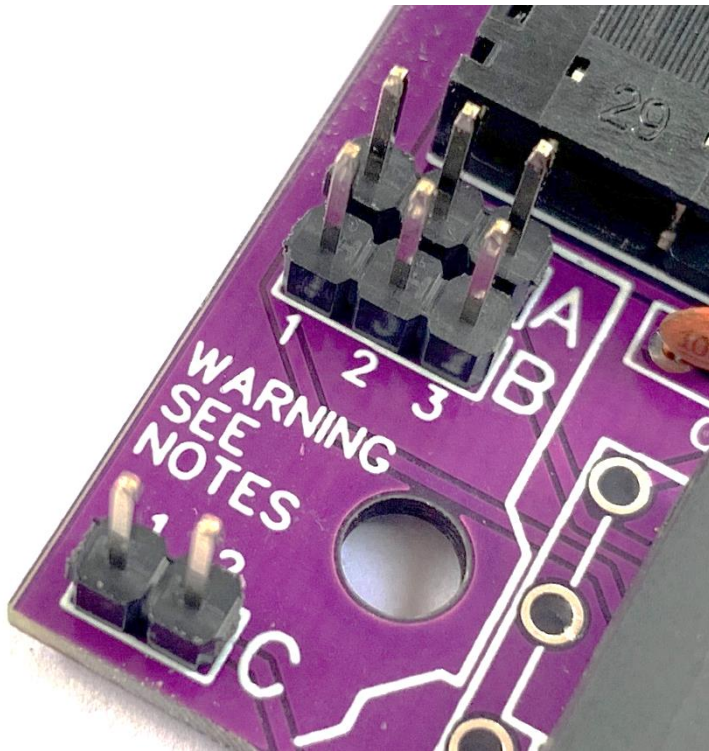

Now fit the keying option header pins.

There are three positions for the header pins , they are marked A,B, and C.

These pins allow the keyer to be set for either just modern transistor rigs or for older valve high voltage Grid block or cathode keying.

The options will be covered later. If in doubt select the grid block setup configuration. It will work with ALL rigs new or old.

Default settings are :- Jumper fitted to

A:- 2&3

B:- 2&3

C:- Jumper fitted

Next fit the Transistors and the voltage regulator.

T1 and T2 are both the same type of transistor, they are standard NPN general purpose types. Normally 2N2222 will be used but many other types are suitable.

The voltage regulator is a 5v regulator 78L05. (VREG on board)

Please make sure that you do not mix up the transistors and the regulator as they look the same. Read the part number on the flat side of each part. Make sure you fit these the same way as the outline on the PCB

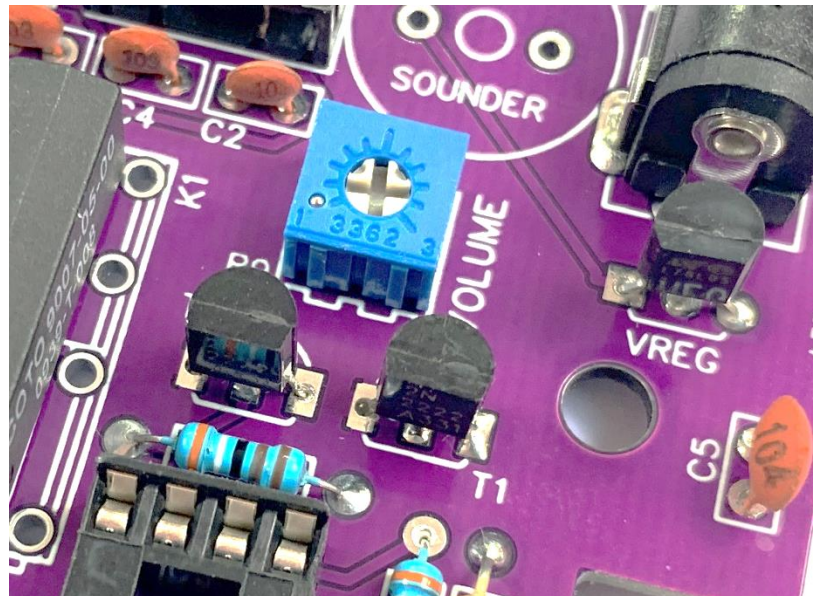



# KANGA PRODUCTS

Electronic Kits For The Radio Amateur

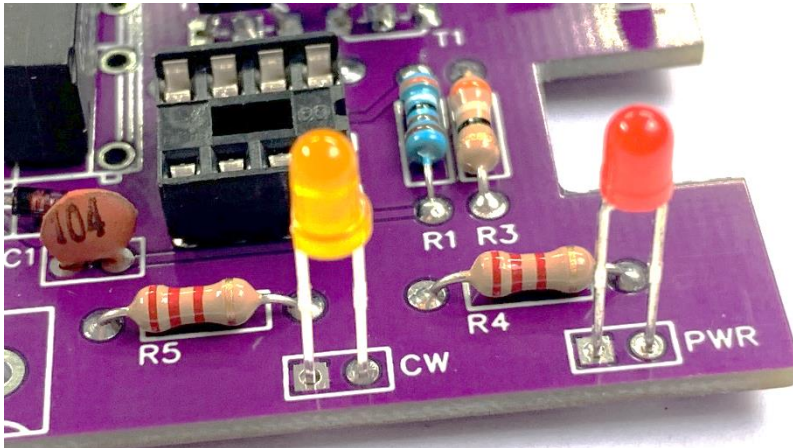

Now fit the two LED indicators.

The red LED is the power on indicator and the Orange is the CW indicator.

If you look carefully at the PCB you will see that for each LED position there are two holes, one has a square pad and the other is round. Each LED has one leg longer than the other. The long Leg **MUST** be placed in the **ROUND** holes. Stand the LEDs about 10mm above the board.

Now for the sounder, The sounder position on the PCB shows the outline with a + sign near one of the holes, look at the top of the sounder and you will see a small circle with a + mark inside. This side of the sounder must be fitted in line with the + marking on the PCB. (See the photo below)

Next we have to prepare and connect the Command push button.



With the kit you will find a short length of wire and some heat shrink. Solder the wire to the two pins of the push button and use the heatshrink to make things nice and tidy, cut the leads to about 50mm.

Strip 5mm of insulation from the ends of the wire and pass them through the PCB's holes marked 'MODE'

**PLEASE READ AND ACTION THE IMPORTANT MODIFICATION FOR THE  
KEYER P.C.B. DETAILED BELOW**



## MODIFICATION FOR MINIATURE RELAY KEYING

Due to a board layout error an additional link is needed on the Rev 1 uQSK PCB, with out this link the relay will be active but no keying of the output will occur. This link is not need if a reed relay is used or the keyer is set for transistor keying .

### REAR VIEW OF PCB

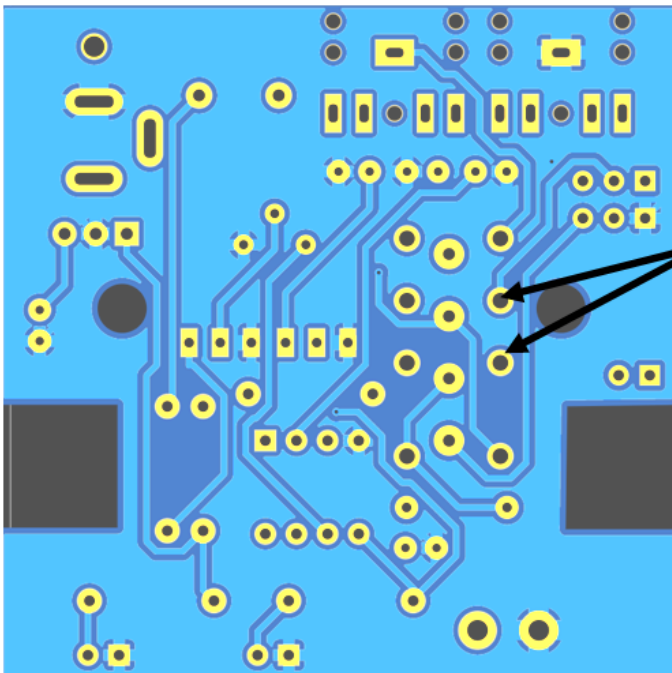

Install Link ON BACK  
of the board between  
these two pads AFTER  
FITTING RELAY

That is the board completed now, we just need to fit it into the case. Now put the rear panel in the case and fit the PCB using the two small PCB screws. Put the spring washer back onto the push button and pass the buttons shaft though the front plate, tighten to the front panel, take care not to mark the panel.

Bend the LEDs and push them though the front panel as in this photo.

When done fit the lid, the 4 stick on feet and the top sticker if you wish. Job done!

See notes at the end of these instructions if you're not sure about the jumper setting.





# KANGA PRODUCTS

Electronic Kits For The Radio Amateur

## Keyer Instructions

Version: 0.87 Usage (WD9DMP Fixes and Enhancements)

After Powerup/reset in default mode, the keyer plays "73" to verify that the Code and EEPROM data are programmed correctly. The circuit operates as a regular IAMBIC keyer in IAMBIC B at 15 WPM (words per minute = 60 CPM), with 800 Hz side tone. By default, the transmitter keying signal is positive. The processor will automatically power off after 60 seconds into a low power mode to conserve power.

### Speed Change

Speed can be changed by pressing and holding the command key while operating the DIT and DAH paddles, in any mode.

DIT reduces speed while DAH increases speed. The keyer plays an alternating sequence of dit and dah while changing speed without keying the transmitter.

### Command mode

Pressing the command button without changing speed will switch the keyer into command mode. This will be confirmed with the '?' character. Another press of the same button takes the keyer back into regular keyer mode and will be confirmed by the 'SK' prosign.

During Command Mode the transceiver is never keyed and sidetone is always activated. Further functions can be accessed by keying one-letter commands as listed below. In general, changes made in Command Mode will be written to EEPROM after a short delay following input and confirmed by an "R" acknowledgement, or by another short press of the Command button (for some commands). The unit will remain in Command Mode for subsequent commands, timing out to Normal Mode after a few more seconds with an "SK" indication. The keyer can also be returned to Normal Mode with an additional button press.

### V -Version

The keyer responds with the current keyer software version number

### P -Pitch

Allows modifying the sidetone pitch to a higher or lower level. A sequence of dits will be played and the pitch can be modified with the dit and dah paddles. If no paddle is touched for 5 seconds, the acknowledgment signal 'R' is sounded and the mode terminates, writing the new pitch to EEPROM and leaving the user in command mode.

### R -Reset

All settings are returned to their default values except for the stored messages in the message EEPROM area. Restored settings include speed and pitch, paddle swap, TX level inversion, sidetone Farnsworth setting, and TX keyer settings.





# KANGA PRODUCTS

Electronic Kits For The Radio Amateur

## **U -Tune**

The transceiver is keyed for a duration of 20 seconds for tuning purposes. Tuning mode is aborted once either DIT or DAH paddles are touched or the control key is pressed.

## **A -Iambic A**

Keyer sets IAMBIC A as permanent keying mode. The setting is written to EEPROM and an 'R' is sounded to acknowledge the request.

## **B -Iambic B**

Keyer sets IAMBIC B as permanent keying mode. The setting is written to EEPROM and an 'R' is sounded to acknowledge the request.

## **L -Ultimatic**

Sets the keyer into ULTIMATIC mode as permanent keying mode. In Ultimatic mode always the last paddle to be touched is repeated indefinitely when paddles are squeezed. The setting is written to EEPROM and an 'R' is sounded to acknowledge the request.

## **D -DAH priority mode**

Sets the keyer into DAH priority mode as permanent keying mode. In squeezed state a sequence of DAHs is sent. The setting is written to EEPROM and an 'R' is sounded to acknowledge the request. Some of the first generation keyers exhibited this behaviour so the chip can simulate that.

## **X -Paddle swapping**

DIT and DAH paddles are swapped. The setting is written to EEPROM and an 'R' is sounded to acknowledge the request.

## **S -Sidetone toggle**

The built-in sidetone generator setting is toggled (ON -> OFF or OFF -> ON). NOTE: This setting is only of relevance for regular keying mode. Sidetone is always on in Command Mode. The setting is written to EEPROM and an 'R' is sounded to acknowledge the request.

## **K -TX keying toggle**

Toggles the setting of the TX keyer output. In default state the keyer switches the output line when it is in keyer mode. Toggling this setting enables or disables that function. NOTE: Keying is always off in Command mode. The setting is written to EEPROM and an 'R' is sounded to acknowledge the request.

## **Z -Set Farnsworth pause**

Allows setting of an extended inter-character pause, which makes fast keying easier to understand. A series of "Dit-Dah" sequences will be played. Pressing the "Dah" paddle will decrease the Farnsworth intercharacter spacing. Pressing the "Dit" paddle will increase the Farnsworth Intercharacter spacing. If no paddle is touched for 5 seconds, the acknowledgment signal 'R' is sounded and the mode terminates, writing the new setting to EEPROM and leaving the user in command mode. Note that this only affects



# KANGA PRODUCTS

Electronic Kits For The Radio Amateur

memory/program playback and transmission. If you desire Farnsworth mode in manual transmission, please manually pause between characters.

## **F (Flip) -TX level inverter toggle**

This function toggles whether the "active" level on the keyer output is VCC or GND. The default is VCC. This setting is dependent upon the attached keying circuit. The setting is written to EEPROM and an 'R' is sounded to acknowledge the request.

## **W -Query current WPM speed**

Keyer responds with current keying speed in WPM.

## **1, 2, 3, 4 -Record internal messages 1, 2, 3 or 4**

The keyer immediately responds with "1" or "2" or "3" or "4" after which a message up to 100 characters can be keyed at current WPM speed. If no paddle is touched for 5 seconds, the acknowledgment signal 'R' is sounded and the mode terminates, writing the new setting to EEPROM and leaving the user in command mode. Choosing "1" or "2" or "3" or "4" but not keying a new message deletes the chosen message buffer content. A command key press during the recording function returns the keyer to command mode, leaving the memory unchanged.

## **E, I, T and M -Play back internal messages 1 or 2 or 3 or 4**

The stored messages 1, 2, 3, or 4 are played back with keying enabled (if configured). A press of the command key aborts the message and immediately returns the keyer to Normal Mode for a QSO, with an "SK" confirmation. After the message plays to completion, the keyer remains in command mode with no "R" indication so another message playback sequence may be started. If no additional message is started, the keyer returns to Normal Mode with an "SK" confirmation.

## **N -Automatic beacon**

The keyer responds with 'N' after which a number between 0 and 9999 can be keyed. After a 5 second timeout the keyer responds by repeating the number and 'R'. Once the keyer returns to keyer mode, the content of message buffer 4 is repeated in intervals of n seconds. The setting is preserved in EEPROM so the chip can be used as a fox hunt keyer. Returning to command mode and entering an interval of 0 (or none at all) stops beacon mode.

## **0 (zero) -Lock configuration**

The 0 (zero) command locks or unlocks the main configuration items but not Version, Pitch, Tune, Callsign Training, WPM Query and Memory Playback functions.

## **C -Callsign trainer**

The keyer plays a generated callsign (sidetone only) and the user must repeat it. If it was repeated correctly, 'R' is played and the next callsign is given. If a mistake was sensed, the error prosign (8 dits) is sounded and the current callsign is repeated again for the user to try once more. If nothing is keyed for 10 seconds, the keyer returns to command mode.



# KANGA PRODUCTS

Electronic Kits For The Radio Amateur

Handy Command Cards to print off

## **Speed Change = Command + Paddle**

**V - Version**

**P - Pitch**

**R - Reset**

**U - Tune**

**A - Iambic A Mode**

**B - Iambic B Mode**

**L - Ultimatic Mode**

**D - DAH priority mode**

**X - Paddle Swap**

**S - Sidetone toggle**

**K - TX Keying toggle**

**Z - Set Farnsworth pause**

**F - Flip TX Level inverter toggle**

**W - Query current WPM speed**

**1, 2, 3, 4 – Record internal message**

**E, I, T & M – Play back message**

**N - Automatic beacon**

**0 (Zero) – Lock configuration**

**Speed Change = Command + Paddle**

**V - Version**

**P - Pitch**

**R - Reset**

**U - Tune**

**A - Iambic A Mode**

**B - Iambic B Mode**

**L - Ultimatic Mode**

**D - DAH priority mode**

**X - Paddle Swap**

**S - Sidetone toggle**

**K - TX Keying toggle**

**Z - Set Farnsworth pause**

**F - Flip TX Level inverter toggle**

**W - Query current WPM speed**

**1, 2, 3, 4 – Record internal message**

**E, I, T & M – Play back message**

**N - Automatic beacon**

**0 (Zero) – Lock configuration**



# KANGA PRODUCTS

Electronic Kits For The Radio Amateur

## Important Information about Setting the Keyer Configuration options

What makes this keyer unusual is its ability to be used with virtually any radio, most keyers will only work with modern transistor rigs with positive keying voltage's and will go 'Poof' if connected to an older or none standard rig. This Kanga Keyer can be used with modern radios and can use a solid state open collector type output switching if required, this is complete silent, or can use a fully isolated relay output that will allow control of both positive or negative keying with voltage up to a few hundred volts. This is the default configuration as it will work with ANY radio. You can of course change this to transistor switching if you wish but of course the keyer will only work with transistorised modern rigs in this configuration.

Here are the configuration options

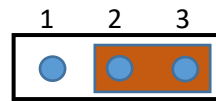
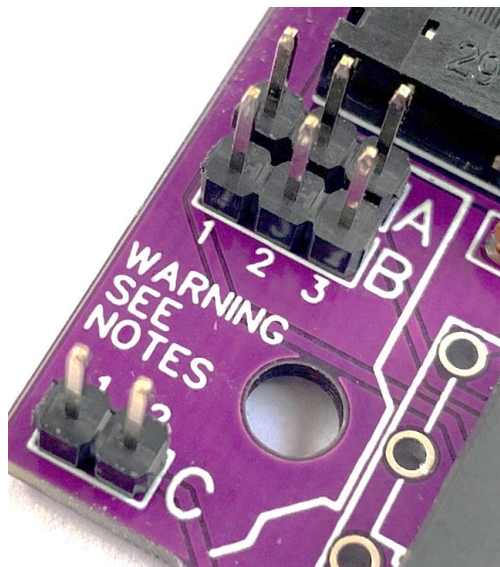

**A**

Default Settings (High voltage relay output)

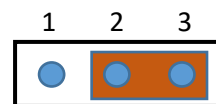

**B**

A : Jumper Pins 2 & 3

B : Jumper Pins 2 & 3

C : Jumper Pins 1 & 2

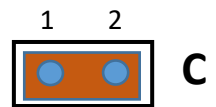

**C**

This will work with all rigs including Valve negative keying radios

The transistor solid state keying jumper 'C' Must be removed.

Jumper 'A' set to 1 &2, Jumper 'B' set to pins 1 & 2

Unless you are confident that you do not need the isolated relay output I suggest sticking to the default option.