



General Purpose Audio Bench Amplifier

Some years ago I had a bench amplifier that I purchased from Tandy's (Do you remember them?) It wasn't the most powerful or highest quality amplifier but it was extremely useful. From boosting the audio from simple radio circuits I made to playing music from a old tape deck with a blown amplifier. It was my go to amplifier for all sorts of purposes. Well that amplifier is now long gone but the need for such a item still remains. This Kit allows you to put together a small self contained amplifier/speaker unit that will sit nicely on your bench in a strong solid case .



Fitted with a 2 inch internal speaker and 6v battery pack (4 x AAA cells) its ready to be used when needed.

The kit is complete with its pre-drilled enclosure to help you build a professional looking amplifier that you can be proud of.

Specification:-

- Power Source :- 6V DC (4 x AAA Cells)
- Amplifier: - LM386
- Features:- Adjustable internal Max Gain control (20-200dB)
- Bass Boost Circuit
- 50mm/2 inch Speaker
- Combined Volume/Power Control
- Power ON LED indicator
- 3.5mm Mono Audio Input socket

The Amplifier is built on a compact PCB .

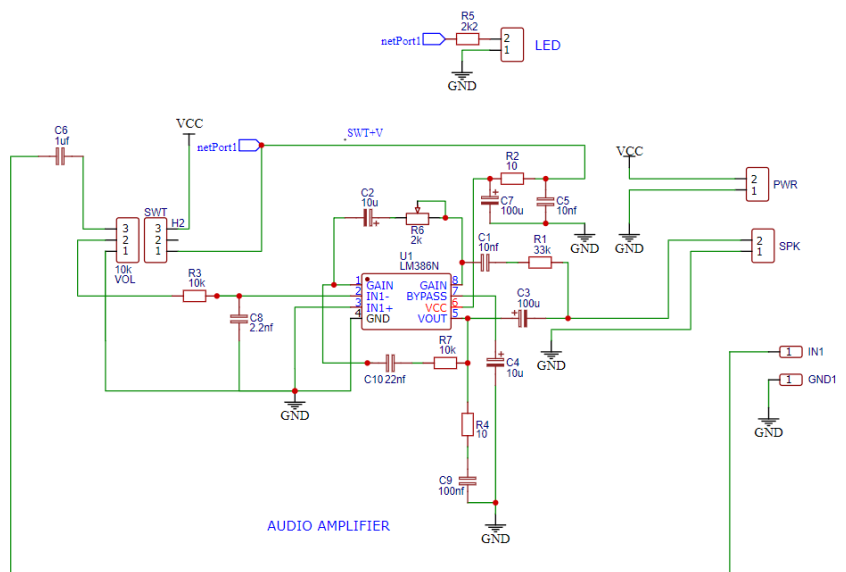
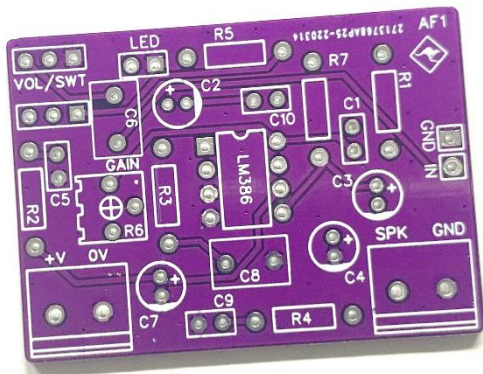



KANGA PRODUCTS

Electronic Kits For The Radio Amateur

Parts List

AF-1 PCB

Amplifier Case

1 x Set of case screws

50mm Speaker & mounting hardware

3.5mm Audio Input Socket

Volume Control knob

4 x AAA Battery Holder

2 x 2 way PCB Terminal Blocks

Amplifier Top Sticker

4 x Stick on Feet

Connection Wire

10K Volume Control c/w Built in switch

LED 3mm power ON LED

Before you start work on the amplifier check you have all the parts listed, any problems contact me

sales@kanga-products.co.uk

We are now moving this project over to a new Part SMD board

If you have this version much of the instructions are no longer valid

See notes below.



KANGA PRODUCTS

Electronic Kits For The Radio Amateur

***** Very Important Note *****

Please make sure you read the instructions below about mounting the volume control or the PCB will not mount correctly into the case. You have been warned!!!

Building the Amplifier

The amplifier is an easy to build project BUT you must follow these instructions for the volume control.

The supplied case has a slight slope to the front panel, if we fit the volume control flush to the PCB the board will be sticking up at an angle that can cause problems with the speaker.

Before fitting the control you will see a small metal tag protrudes just below the adjustment shaft, it's only about 1-2mm long. Use pliers /cutters to snap this off.

When mounting the volume control, see the picture for this, the back of the control must sit higher than the front. The rear pins on the control must just be visible and no more, this will allow the PCB to sit correctly in the case.

Make sure that you follow this section of the instructions if nothing else after it!

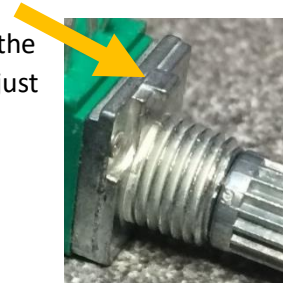
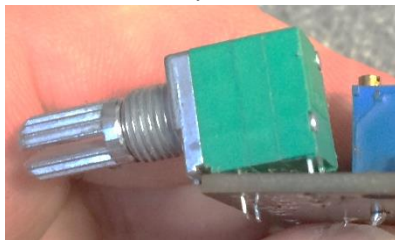

On with the Build!

If you have the new SMD board you can jump to step 4

Step one

Fit the IC socket,

The IC Socket sits in the middle of the board.

If you look at the socket you will notice a small notch on one of the shorter edges. This notch side should be placed so it is nearest to the top of the board near to C2 and C10 position.

Some people do not like to use sockets and yes they can cause problems at HF /VHF frequencies. Our amplifier is only working at audio frequencies so there is no problem using sockets. Since the only active part on the board is the IC it makes more sense to use the socket so if anything goes wrong with the amplifier it's an easy job to just un-plug the chip and replace it.

If you really don't want to use a socket then just solder the Chip to the board at this stage but I strongly recommend fitting the socket.

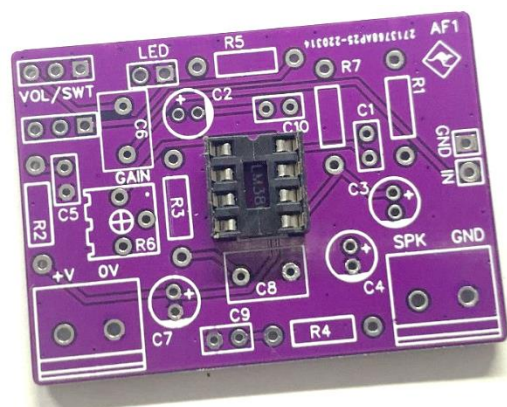



Step 2

Fitting the resistors.

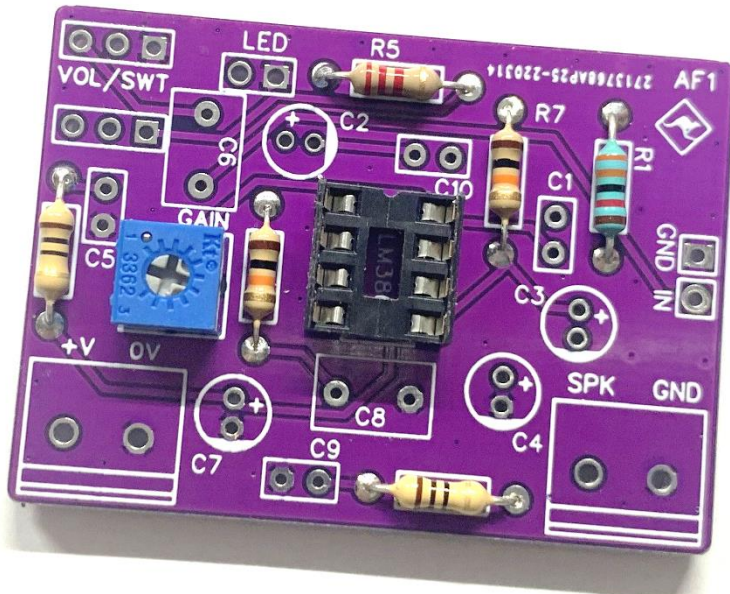

Resistors can be fitted either way round but you must make sure you fit the correct value resistor in the correct place. Resistors have colour bands on them that tell us their value. I have supplied a colour resistor chart that should help you check the value of the resistors. I tend to use a test meter to check any resistors I fit.

Some resistors have 4 bands others 5 bands (just to add to the confusion!)

R1 = 33K so the first two bands will be Orange, Orange.

R2 and R4 are both 10 ohms, their first 3 bands are Brown, Black, Black .

R3 and R7 are both 10K ohms (that's 10,000 ohms) they have bands Brown, Black, Orange.

R5 is 2K2 , this has Red , Red, Red bands. This resistor controls the brightness of the power on LED, if you wish you could fit a 1K resistor if you want a really bright LED (too bright for me!) or you could fit a higher value like 3K9 or 4K7 if you want a dimmer LED. I think 2K2 is just about right.

R6 is different from the other resistors, it is a small trimmer . This trimmer will allow you to change the gain of the amplifier. It can be adjusted to change the gain between 20 and 200dB but more on that later.

Step 3

Fitting the capacitors

We have used a selection of different type of capacitors. some of these capacitors can only be fitted one way.

There are 4 such capacitors in this amplifier C2/C4 which are 10uF 25v, and C3 /C7 which are 100uF 25v.

These capacitors are call electrolytic types. They have two legs. One is longer than the other. This long leg is the Positive leg and should go into the hole with a '+' marked next to it.





KANGA PRODUCTS

Electronic Kits For The Radio Amateur

Fit C1 and C5 both of these are 10nF disk type capacitors. They will be marked 103 on one side of the disk. These can be fitted either way round.

Next fit C9, this is also a disk type but will be marked 104.

Fit C10 next which will be a disk marked 223.

Now fit C8 which is a green coloured 'Pillow' type capacitor (so my XYL calls them) .

Next fit C6, this is a 1uF yellow capacitor marked 105.

Now we will fit the electrolytic capacitors.

Start with C2/C4, these are marked 10uF 25V, make sure the long leg goes into the hole marked with '+'

Now fit C3/C7. These are marked 100uF 25V, again make sure the long leg goes into the hole with the '+' mark next to it.

Step 4

The Power and Speaker Blocks

These two blocks allow you to connect the power leads and speaker leads to the board. The terminal blocks have an opening on one side for the wires to go into. Make sure that the opening is next to the edge of the board!

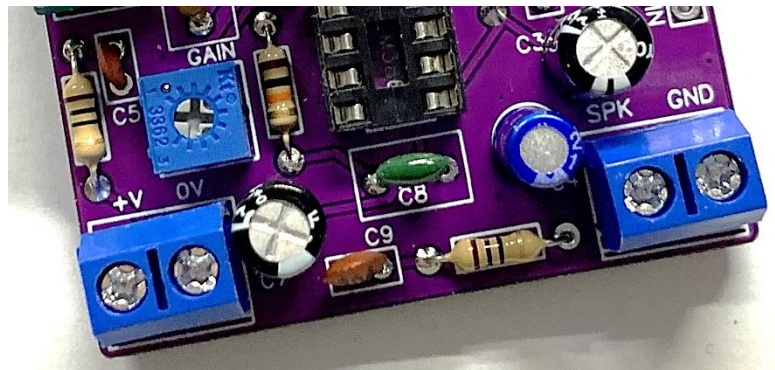

Fit and solder these in place. Now a confession, when I designed this board it would have been better if I gave you a larger soldering pad for each of these terminals and I will on the next batch of boards but just make sure you solder the pins of the blocks well.

Step 5

Fit the Volume control

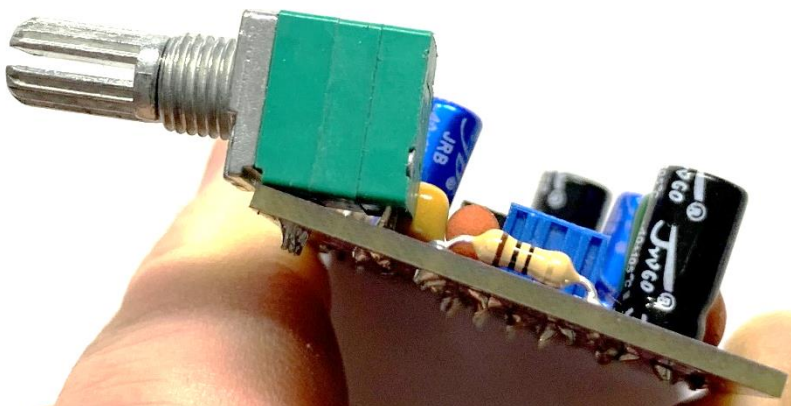

Now refer back to note at the start of the build instructions about snapping off the tag and fitting the control so the back pins JUST are flush with the board, the control needs to be installed at angle to compensate for the slope of the case front.



Step 6

Fit the Power LED

The LED has two legs, one is longer than the other. On the board next to the volume control is where the LED is fitted. You will see the position for the LED has a square and a round pad.

The Long leg of the LED must go into the round pads hole. Make sure that's correct before soldering the LED, the LED should be fitted so the top of the LED is JUST higher than the top of the volume control.

Once fitted fold the LED down as shown in the pictures below.

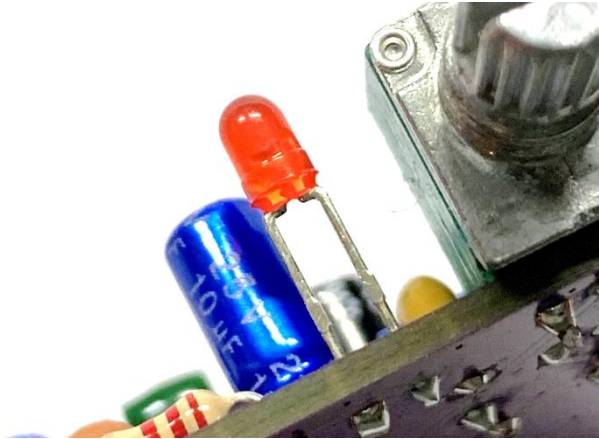

Now the board itself is completed.



Step 8



Check for errors

So before we move on we will check the board for any mistakes.

Take your time and check you have fitted all the parts in the correct places.

Check that you have not missed any soldering or have caused shorts between pins with blobs of solder.

I use a small magnifying glass to check my boards.

Do any rework that you need to. All the solder joints should be nice and bright.

Next we need to wire the input socket, so find the socket and the short wire length, I have also included a short length of heat shrink for this stage. You don't really need to use the heat shrink but it makes for a nice neat job.

Step 9

Wiring the Input Jack socket.

The input socket has four pins we are only connecting to two of them.

This image represents the REAR view of the input jack socket.

The picture exaggerates the offset in the pins to make things clearer, if you look at the back of the socket you will note that the two side pins are nearer one end of the socket than the other, it is VERY important that you get this right so take your time.

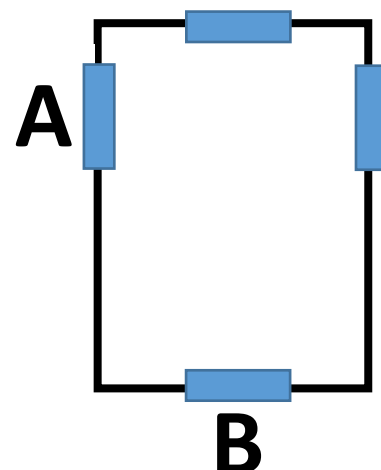
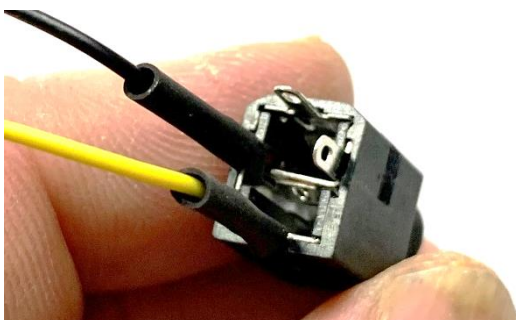



KANGA PRODUCTS

Electronic Kits For The Radio Amateur

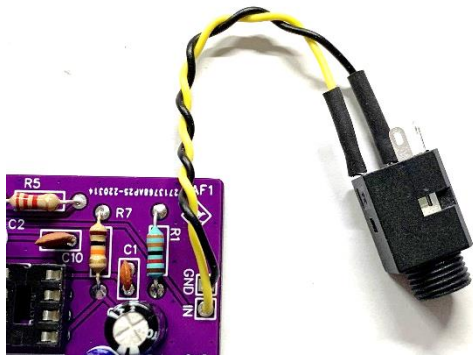

The PCB has two pads for the input socket to connect to. One marked 'GND' and one marked 'IN'. GND must be connected to the pin above marked A, the 'IN' pad to the pin marked B above. Trim the wires so that they are about 50-60mm long and use the heat

shrink on the pins of the socket to make it neat.

The speaker will already be fitted to the base plate but you will need to solder two wires to the speaker terminals (about 100mm long). Once soldered I lightly twist the wires together.

Step 10

Fitting the amplifier in the case

The first part of this is to fit the socket to the front of the case. Take care doing this so you don't mark the case.

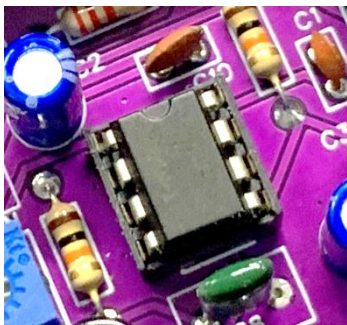

Now before we put the board in place you can fit the IC to the board. The chip has a small notch on one short edge. Make sure this notch is nearest to C10 and C2 on the board.



Carefully push the board forward so that the LED goes into the 3mm hole and the volume control goes into its hole, the LED will fold back on itself as it goes through the hole.

Now wire the speaker to the right-hand side blocks and the battery holder to the left-hand side. Note the polarity of the battery holder (see markings on the board)

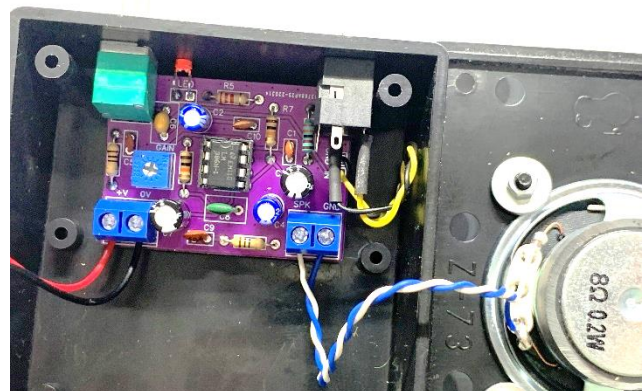



KANGA PRODUCTS

Electronic Kits For The Radio Amateur

Now we are almost ready to test our amplifier.

Remember the Gain control (R6 trimmer) on the board? Well for now we will set this for MAX gain, turn the trimmer fully clockwise.

Fit the batteries, the holder should be placed at the opposite end of the case to the amplifier. You will see a foam strip fitted to the case there. This strip stops the battery pack from moving when the base plate is fixed. Now screw the base plate onto the case, the speaker is slightly off set from centre, you will find that the offset will allow the speaker plate to fit without hitting the battery pack so try it both ways to find the best fit. Secure speaker plate onto the box with the 4 screws provided.

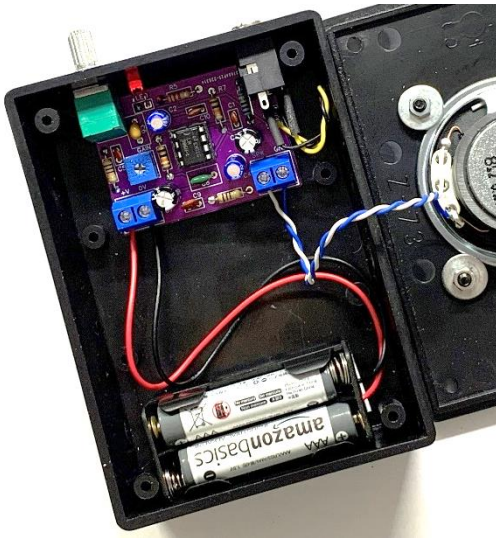

Fit the Control knob and if you wish the top sticker to finish off the amp. (may already be fitted by me!)

Now the Amplifier has a 3.5mm Jack socket input so you will need a lead to connect the amplifier to what ever you are using it with, remember that this is a mono amplifier and not as it stands suitable for use with a Stereo signal (see possible mods below)

I use this amplifier with the Kanga Crystal radio kit and it works great!

I Hope that you find the amplifier useful.

73 Paul MOBMM





Possible Modifications

For most people the amplifier will be fine as is. If you intend to use it with a stereo input then you can do a very simple modification.

Of course a stereo signal has two channels and a mono amplifier would only amplify one of them so we need to do a simple modification if we want both channels to be amplified and mixed into a mono amplifier.

The socket used on the amplifier is in fact a stereo socket so by just adding two resistors to the back of this socket we can mix the left and right channels.

